

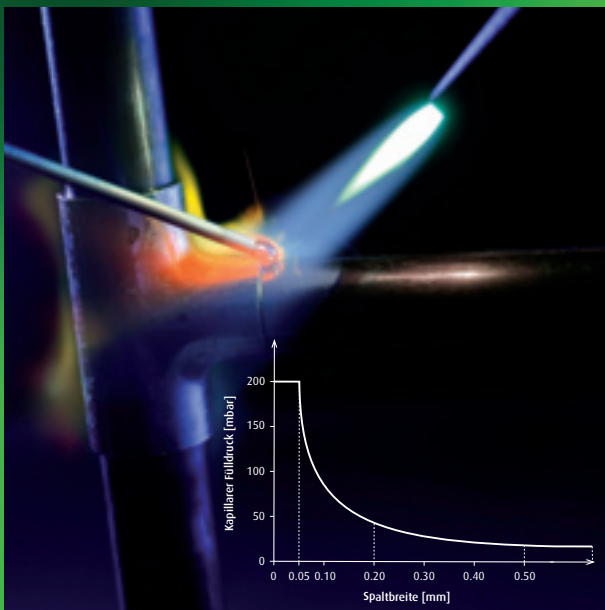

Principles of Brazing and Soldering

Joining Technology



Brazing is BrazeTec 

Principles of Brazing and Soldering

Joining Technology

By Daniel Schnee
Technical Materials
BrazeTec

Brazing is BrazeTec 

Page 4	1. Introduction
Page 6	2. Metallurgical and Physico-Technical Basics
Page 10	3. Wetting and Diffusion
Page 12	4. Brazing Techniques
Page 15	5. Filler Metal
Page 16	6. Fluxes
Page 19	7. Solderability of Components
Page 20	8. Annex
Page 22	9. Glossary

1. Introduction

In joining technology, we differentiate between non-positive and material bonding connections. Non-positive connections are made by rivets or bolts, while gluing, welding, brazing and soft soldering are typical material-bonded connections – see **figure 1**.

Figure 1 | Types of joints

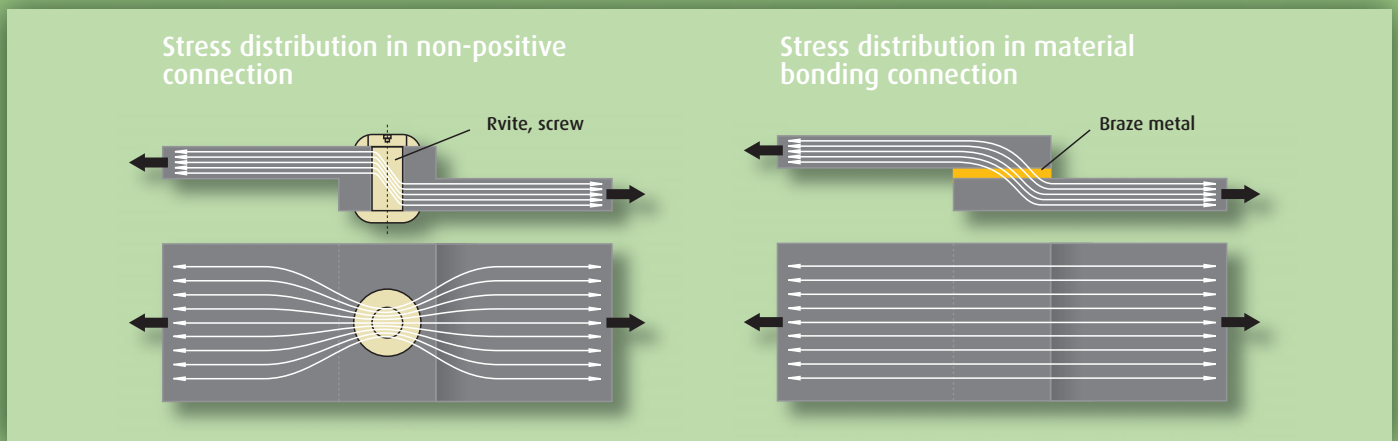

Brazing is a thermal process for material-bonding and separable joining and coating of materials, in the course of which a liquid phase is created by melting a filler metal (also called brazing alloy) in a fusion brazing process (fusion brazing) or by diffusion at the interfaces (diffusion brazing). The solidus temperature of the parent materials is not reached [1].

As a consequence, filler metals must have several essential characteristics:

- the melting temperature must be lower than that of the parent materials
- parent materials must have good wetting properties
- a high degree of stability and tenacity

To be able to better understand these characteristics, it is essential to be aware of the

physical and metallographic basics not only for the development of new filler metals but also for effective application of the large variety of fillers already in use.

To learn more about the technical terms used, please refer to the annexed glossary.

1.1 Differentiation Between Welding And Brazing

In welding, materials of the same type may be bonded with each other, e.g. steel with steel or aluminium with aluminium. The weld metal has a similar composition as the parent material and is thus specific to the material.

In brazing and soft soldering, however, materials of the same type and also dissimilar metals may be bonded to each other, e.g. steel with copper or copper with brass. The

filler metal i.e. brazing alloy is usually not specific to the parent material. Composition of filler materials may differ significantly from that of the parent materials – see **figure 2**.

Distinction is made between

- soft soldering with filler metals having a liquidus temperature under 450 °C.
- brazing with filler metals which have a liquidus temperature above 450 °C.
- high-temperature brazing in a vacuum or protective atmosphere with filler metals having a liquidus temperature above 900 °C.

Figure 2 | Schematic comparison of temperatures of welding and brazing

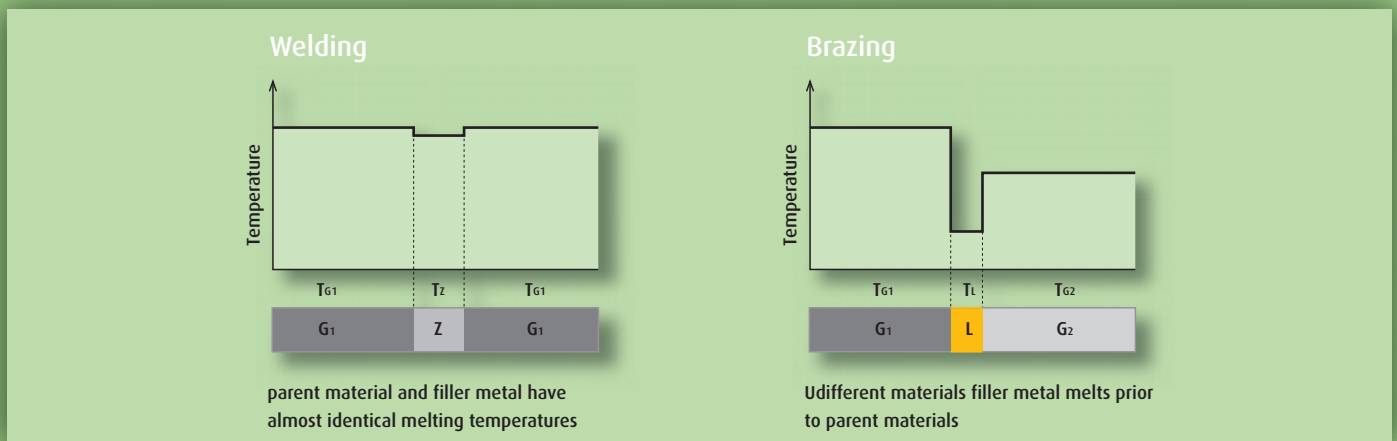

2. Metallurgical and Physico-Technical Basics

In describing the metal filler characteristics stated in the introduction, one will frequently encounter technical terms such as liquidus temperature, solidus temperature, metal filler formation, eutectic alloys, diffusion zone, etc.

For a better understanding of the technical basics, we have to mention a few theoretical fundamentals.

Figure 3 | Metal crystal lattice with copper and nickel atoms

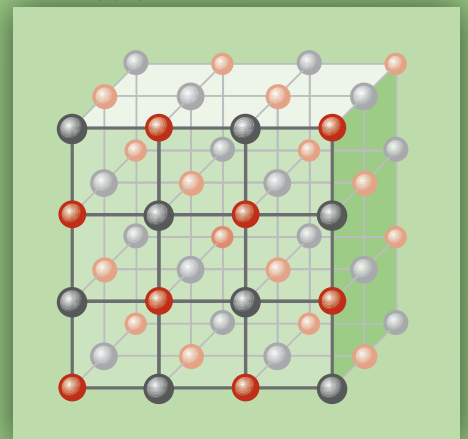

2.1 Phase Diagrams

To be able to properly assess and apply filler metals, it is absolutely essential to be familiar with the melting characteristics of the particular metal or alloy. Only few pure metals (e.g. Cu) are used as a brazing filler metal. Usually mixtures of two or more metals are used, called alloys.

The measured data obtained from heating or cooling curves is used for compiling so-called phase diagrams. For alloys composed of two metals, these are called binary phase diagrams. The upper curve is known as the liquidus line (L); the temperature it displays is the liquidus temperature. The lower curve showing the solidus temperature is named the solidus line (S) - see **figure 4**.

Above the liquidus line, the entire alloy is molten and liquid; below the solidus line, the

alloy is entirely solid. In the cigar-shaped zone, alloys have both solid and liquid phases and the overall consistency accordingly is pasty. This zone is called the melting range or with falling temperatures the solidification range.

Figure 4 shows the binary phase diagram for the two metals copper (Cu) and nickel (Ni). Both metals are entirely miscible throughout the entire concentration range; a feature displayed by only a small number of systems e.g. silver-gold, copper-zinc (up to 45 wt% zinc).

The binary phase diagram shows that alloying a second metal either changes the melting point or establishes a melting range. Adding copper lowers the melting point of nickel, for example.

Metals have a regular structure, in which the atoms are arranged in a metal crystal lattice - see **figure 3**. In alloys, the metal crystal lattice is composed of the atoms of the alloying com-

ponents. If the atoms of the metals of an alloy have a similar size, such as copper and nickel, the integration of foreign atoms is not a problem and the metals are absolutely miscible.

The integration of very large atoms instead of

Figure 4 | Copper-nickel diagram [2]

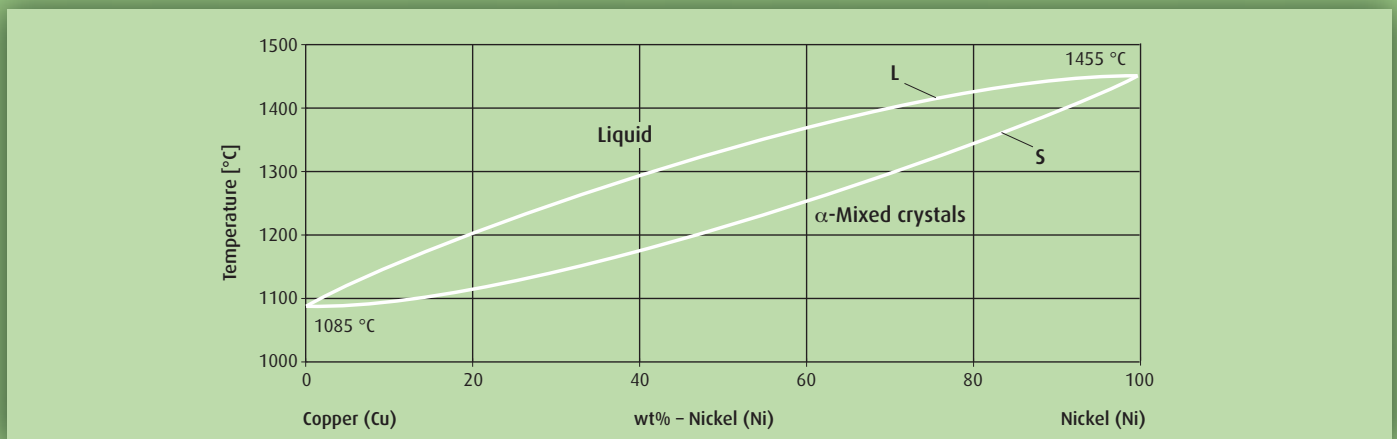

the original atoms is possible only to a limited extent, which is known as partial solubility. This phenomenon frequently leads to changes in strength and melting ranges as well as lower melting temperatures. In systems featuring limited solubility of metals into each other, there are frequently melting temperature minimums (eutectic points) as displayed in **figure 5** for the copper-silver system.

With a copper share of 28 weight-%, the molten mass solidifies at 780 °C and reacts like a pure metal during solidification. In other concentrations, the liquidus temperature rises consistently up to the melting point of the pure metal.

2.2 Filler Metal Melting Range

The extent of a filler metal's melting range is determined by the difference between the liquidus and solidus temperatures.

The melting range is decisive in choosing a filler metal for brazing and also influences the time needed for heating and the brazing period [3].

Only filler metals with a narrow melting range should be selected for furnace brazing. Wide ranges could lead to the formation of segregation zones. As soon as the solidus temperature is reached, the filler metal begins to melt. This partially liquefied material consists of the filler metal alloy components with low melting points. They wet the parent material and flow into the brazing gap. The remainder of the alloy

component with higher melting points has an aggregate state different from that of the initial liquefied mass and remains in a non-molten state at the application spot. For alloys with narrow melting ranges, the beginning and end of liquefying of the filler metal lie close to each other, which prevents the formation of these material residues.

Filler metals with wide melting ranges are predominantly used for manual brazing processes and allow filling of wider brazing gaps.

2.3 Brazing Filler Metals With Low Melting Points

Low melting temperatures or low melting ranges are significant features of any filler metal, because these lead to low brazing tem-

Figure 5 | Binary phase diagram: silver / copper [2]

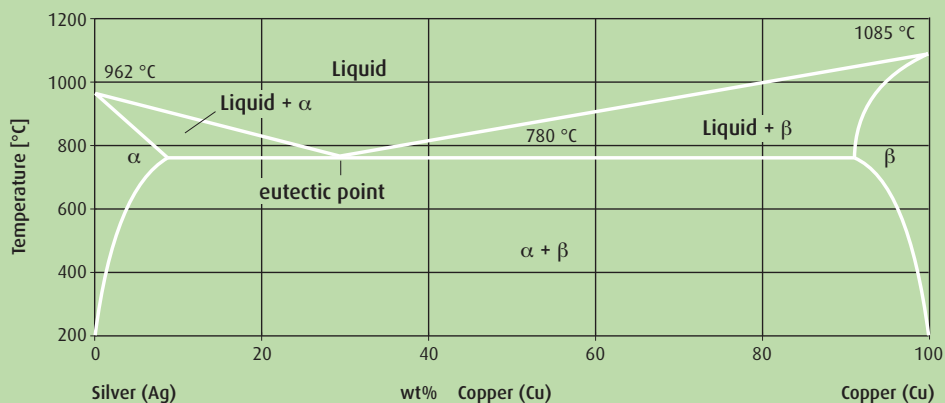

Figure 7 | Steel rods brazed at about 830 °C.
 Top: with silver-free brass brazing alloy^{*)}, the brazed joint is not ductile;
 Below: with BrazeTec 1204, the brazed joint is ductile.

^{*)} Brass brazing alloys with such low brazing temperatures are not suited for technical applications due to their brittleness and are therefore not produced on an industrial scale. This filler metal was manufactured particularly for this test.



peratures.

Next to silver, another metal capable of reducing the melting temperature of copper is zinc (Zn). To prevent the filler metal alloy and thus the brazing joint from embrittlement, the zinc content of these brass alloys should not exceed 45 wt%. Other metals with low melting points lead to embrittlement (e.g. cadmium, tin, aluminium and Magnesium) or cause thermal embrittlement (e.g. lead, bismuth and antimony of the filler metals and brazing joints).

The precious metals gold (Au) and silver (Ag) lower the brazing temperature of the Cu-Zn alloys without embrittling these. The more favourably-priced silver has even better effects than gold. The lower curve in **figure 6** demonstrates that 10 wt% silver is more effective than

45 wt% zinc (solidus temperature is lowered by approximately 250 to 300 °C) and that this effect is consistent at all zinc contents up to 30 wt% (lower curve is parallel to upper curve).

Figure 7 shows the malleability of a silver-free brass brazing alloy with a liquidus temperature of approx. 800 °C in comparison with the silver brazing alloy BrazeTec 1204 (12 wt% Ag; liquidus temperature 830 °C). Two steel rods are butt-jointed with one of the two filler metals respectively. While the joint brazed with BrazeTec 1204 can be bent without failing, the silver-free joint fractures and breaks after being bent by only 0.5° [4].

The composition of the major components of the low-melting BrazeTec brazing alloys – silver, copper, and zinc – is selected to assure out-

standing processing capacities - low brazing temperature, easy flow, high stability. The ratio of the filler metal components to each other is held constant within relatively tight tolerances.

Brazing filler metals for particular applications contain more components to improve wetting of the parent materials. Filler metals with nickel and manganese additions are used for carbide tools. Their ratio of components is designated to assure maximum processing characteristics without greatly influencing other brazing features.

Figure 6 | Reduction of solidus temperature – a) with Zn alone, b) with Zn + 10 wt% Ag

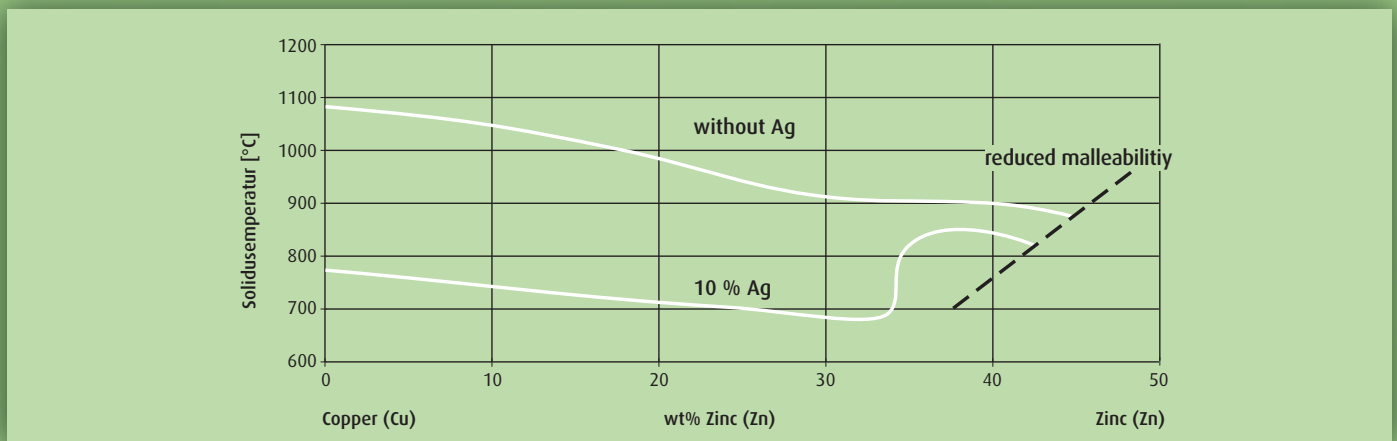

3. Wetting and Diffusion

Filler metals will effectively wet the parent material only if three essential requirements have been met:

- The surfaces to be brazed and the filler metal have to be metallurgically clean.
- The surfaces to be brazed and the filler metal have to reach at least the working temperature.
- At least one filler metal element has to be able to alloy with the parent material.

Figure 8 | Wetting angles

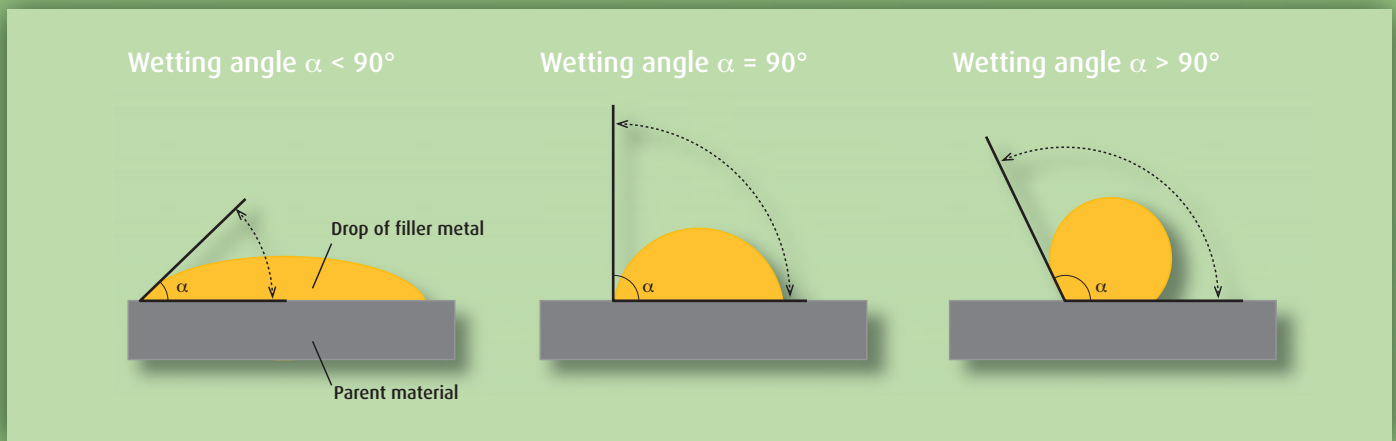

3.1 Wetting

Next to low brazing temperatures, another criterion to be looked into is the ability of the filler metal to wet the parent material.

A drop of liquid filler metal touching a solid metal surface will wet this surface and will spread to a certain degree [5]. Preconditions for this wetting and expanding are a clean and oxide free metal surface, sufficient heating of the filler metal and parent material, and low-viscous capacities of the molten filler metal.

The wetting angle α is a measurable variable for wetting abilities and designates the angle measured between a drop of filler metal and the level parent material surface – see **figure 8**.

- With $\alpha = <90^\circ$, the parent material is wetted. Optimal wetting angles are at $<30^\circ$. With $\alpha = 0^\circ$, wetting is total, i.e. the drop of filler metal extends over the metal surface in form of a thin film.
- With $\alpha = 90^\circ$, the drop of filler metal has wetted the surface, but it has not spread.
- With $\alpha >90^\circ$, there is no wetting.

3.2 Diffusion

In a successful brazing process, the brazing filler metal partially alloys with a thin layer

of the parent material surface. The migration of metal atoms essential for this process is called diffusion. Accordingly, the developing transformation zones are also called diffusion zones - see **figure 9**. Filler metal components are found in the parent material (DP); constituents of the parent material can be detected in the filler metal layer (DF) [6].

The consistency of brazed joints is based upon the formation of a diffusion zone. To provide for formation of these zones, the atoms of the brazing alloy must be integrated into the metal atom structure of the parent material. Of course not all metal atoms feature identical abilities to fulfil these requirements on solid solution formation. The larger the differences in atomic radii, the smaller the number of atoms to be integrated and possibly the slower their ability to move. In order to achieve optimal consistency, the filler metal should have a liquid phase of at least 5 to 10 seconds to assure formation of an adequately deep diffusion zone.

Filler metals should therefore always contain a metal which is also a component part and/or alloying element of the parent material at issue. The alloying element zinc, for example, meets this requirement very well for all steels and in nickel and copper based alloys.

3.3 Changes of Microstructure

Brazed joints have a zonal structure. Next to the unaffected parent material (P) is a thermal influence zone (PI), in which the parent material microstructure changes due to crystal regeneration, recrystallization, tempering, precipitation processes or transformation of the crystal structure, etc. [7]. The alloy layer D is the transformation zone between the parent material and filler metal and consists of the diffusion zones DF and DP (see 3.2.). In brazing, this layer can be so thin that it is almost undetectable under the microscope. Next is the zone of pure filler metal F – see **figure 10**.

Not all of these zones must always be present. Formation of the heat affected zone depends upon the brazing temperature and time. The zone of pure filler metal may disappear entirely, in particular if there are narrow brazing gaps and favourable diffusion conditions (high brazing temperature, long brazing period).

Figure 9 | Successful brazing with defined diffusion zones

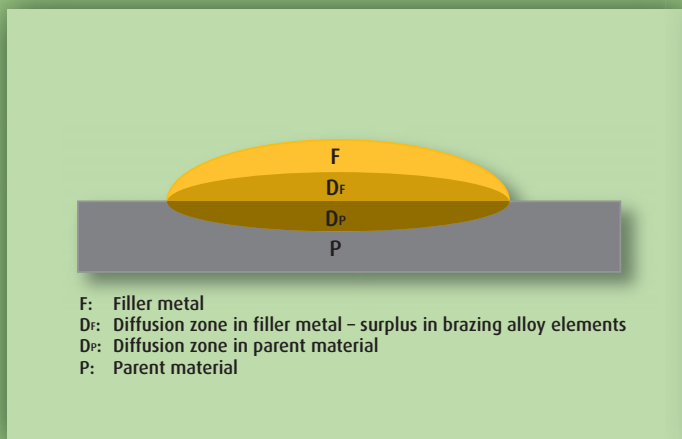
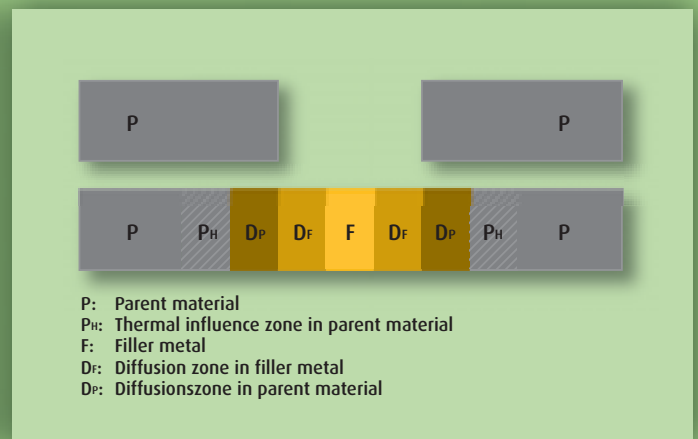

Figure 10 | Structural arrangement in brazed joints



4. Brazing Techniques

In brazing technology there are many possibilities to categorise brazing technology like liquidus temperature of filler metal, method of filler metal application or heating technique. In this chapter the techniques were classified by form of braze joint.

Figure 12 | Flow of filler metal during gap brazing

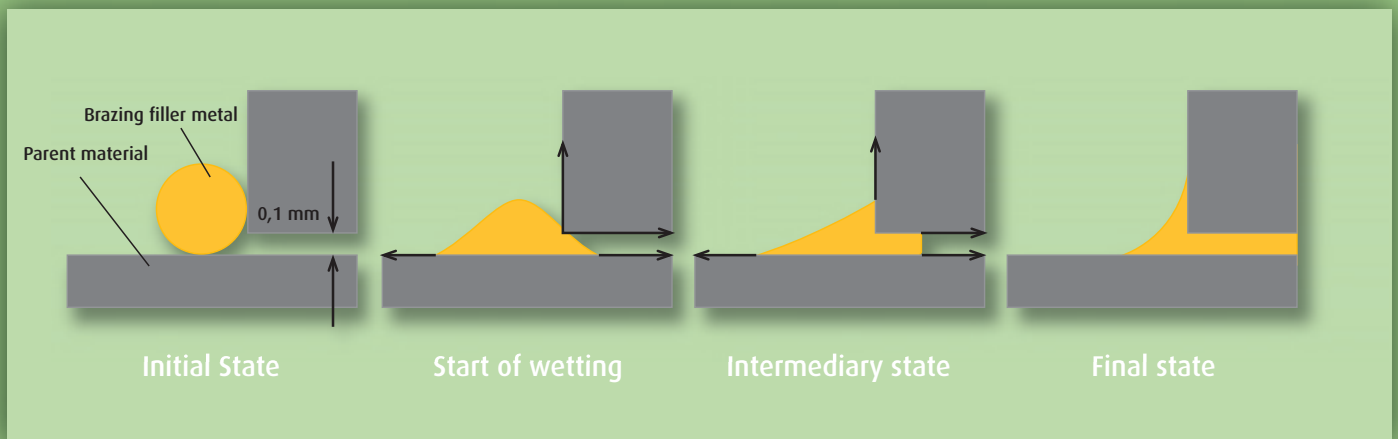
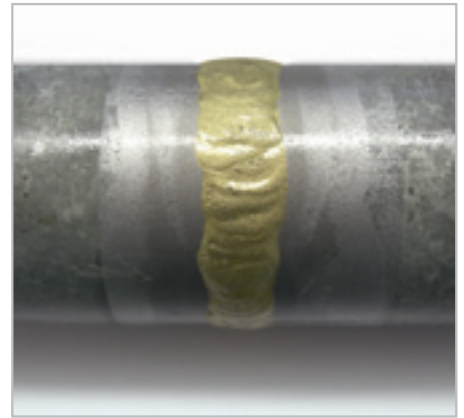

Figure 11 | Galvanized steel pipes braze welded with BrazeTec 60/40



4.1 Braze Welding

Braze welding is a brazing technique in which the surfaces to be joined to each other have a gap of more than 0.5 mm. Owing to this large distance, the strength of the applied filler metals should be higher than that of the parent material in order to warrant for sufficient strength of the brazed joint [8]. The liquidus temperature of the filler metal may not be significantly exceeded in order to prevent the filler metal from seeping out of the joint.

The seam preparation and working technique for braze welding are the same as for gas welding.

This technique is primarily used for joining galvanized steel pipes – see figure 11.

4.2 Gap Brazing

In gap brazing, the workpieces are treated and

prepared so the joints form narrow capillary gaps. They are uniformly heated to brazing temperature across the entire length of the gap. The liquid filler metal is forced into the gap by the capillary attraction – see figure 12. The majority of all brazing operations are carried out by gap brazing.

If the joint has been brazed in an open atmosphere using a flux, the filler metal penetrating into the gap has to be able to displace the flux from the gap.

In gap brazing, the liquidus temperature of the filler metal may be exceeded by 20 to 50 °C in order to assure uniform filling of the gap.

4.2.1 Capillary Attraction

narrower the joint gap is, the greater the capillary attraction will be.

With a parallel gap of 0.1 mm, the capillary

pressure is at approx. 100 mbar (10 kPa). This corresponds to a filler metal rise height of 10 cm (filler metal density = 10 g/cm³) – see figure 13. The calculated rise heights have been confirmed in practical tests [9].

The correct dimensioning of joint gaps (gap width) and cleanliness of the brazing surfaces are crucial factors for determining the capillary attraction [10]. Excessively large gaps and improperly cleaned surfaces reduce the capillary pressure and lead to brazing gaps being only partially filled.

The high capillary pressure in gaps smaller than 0.05 mm is exploited for brazing operations in protective gas atmospheres or vacuum. For mechanized brazing with fluxes, the gap range is between 0.05 to 0.2 mm. Up to a gap size of 0.2 mm, the capillary attraction is sufficient to assure adequate penetration and filling of the gap with filler metal. Wider gaps

Figure 13 | Capillary pressure dependent on gap width

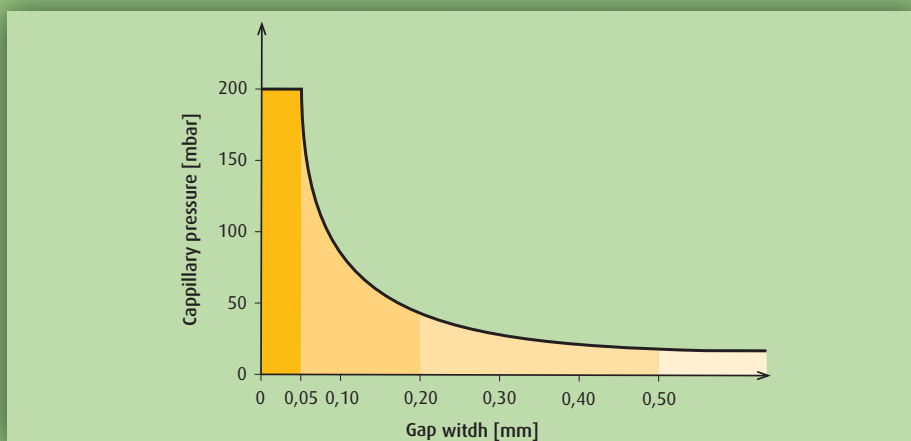

are difficult to fill and are therefore not suited for mechanized brazing. The range up to 0.5 mm is still suited for manual brazing [11]. For gap widths exceeding 0.5 mm, the low level of capillary pressure prevents reliable and uniform filling of brazing gaps with filler metal.

The minimum size for brazing with flux is a consequence of the need to pull sufficient flux into the gap in order to eliminate any oxides still deposited on the surfaces.

The gap width ranges for various brazing techniques are displayed in **figure 14**.

In addition to the size of the gap, also the gap geometry has a significant impact on the capillary attraction and thus also on the brazing results. The capillary pressure in the fillet is 4.5 times higher than that registered for a regular parallel gap between flat surfaces – see **figure 15**.

4.3 Surface Brazing

Surface brazing is not aimed at joining parts by way of brazing with filler metal, instead the filler metal and optional additives are applied to the parent material surfaces to increase hardness and as protection against wear and corrosion.

With the BrazeCoat® technique [12], the surfaces of component parts subject to high stress are protected against wear and tear by applying a hard material / brazing web which is then melted in a furnace process. The applied layers are compact, smooth and have almost no pores and are used to protect ventilator fan blades, mill housings, heavy-duty transport pumps as well as cylinders, pistons, and piston rods in hydraulics and pneumatics engineering.

Figure 14 | Gap width for various brazing techniques

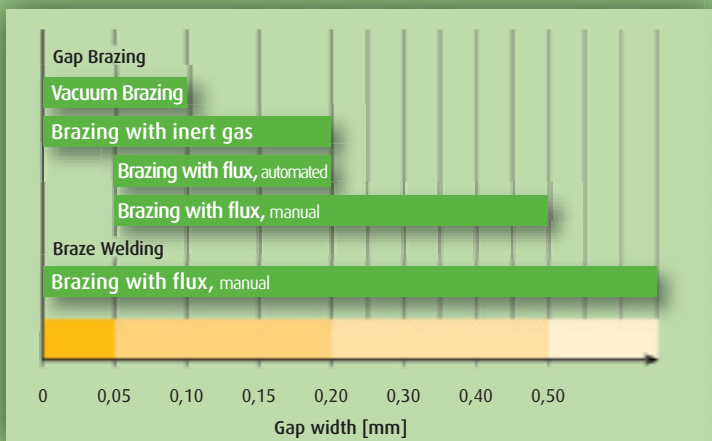
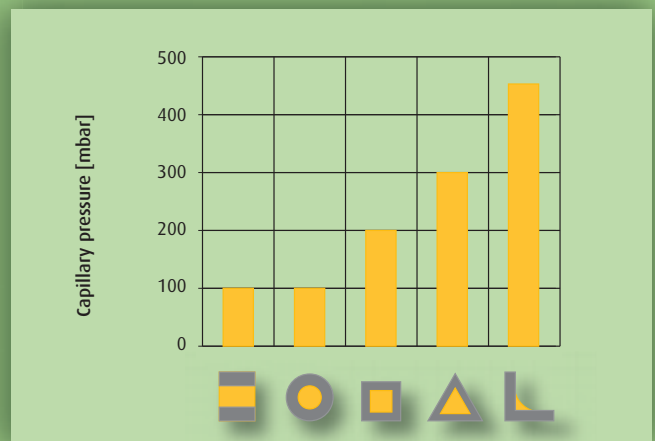

figure 15 | Capillary pressure dependent on gap geometry



5. Filler Metal

DIN ISO 857-2 defines filler metals with a liquidus temperature of under 450°C as soft solders and over 450 °C as brazing filler metals.

The brazing/soldering ranges are determined at the lower end by the melting range and at the upper end by:

- the flux (which becomes saturated with oxides if the temperature is too high or is subjected to an extended heating period)
- the filler metal (some alloy components may evaporate)
- economical considerations (unnecessarily high temperatures waste valuable time and energy)
- the parent material (structural changes; loss in stability)

5.1 5.1 Soft Solders

Solders are listed in DIN EN ISO 9453 and are distinguished as lead containing and lead-free alloys [13].

The lead containing solder alloys (tin/lead, lead/tin, tin/lead/antimony, tin/lead/bis-

moth, tin/lead/cadmium, tin/lead/copper, tin/lead/silver and lead/silver) have a melting range from 145 to 370 °C.

The lead-free solder alloys (tin/antimony tin/bismuth, tin/copper, tin/indium, tin/silver and more complex compositions) have a melting range from 118 to 380 °C.

Lead is considered to be carcinogenic and is consequently no longer used as a solder in numerous industry sectors, in particular in utilities plumbing and in the electronics industry.

5.2 Brazing Filler Metals

Brazing filler metals are defined in DIN EN ISO 17672, where they are categorized in seven groups according to their major alloy element – see **figure 16** [14].

In addition to standardized brazing alloys, other alloy groups are also known in industrial manufacturing processes:

CuPSnNi alloys with a melting range from 590 to 620 °C for brazing copper-brass coolers in the so-called “CuproBraz® process” [15].

Active brazing alloys – have a silver/titanium basis with the addition of copper and indium for the brazing of ceramic materials at temperatures between 850 and 1050 °C [16].

Copper-manganese-cobalt alloy with a melting range between 970 and 990 °C are used for brazing cemented carbides on steel parts in protective gas atmospheres.

Since December 2011, the use and marketing of cadmium containing brazing filler metals in the EU is no longer permitted. These alloys could only be used in defence and aerospace applications or for safety reasons [17].

Figure 16 | Melting temperature range of filler metal groups acc. to DIN EN ISO 17672

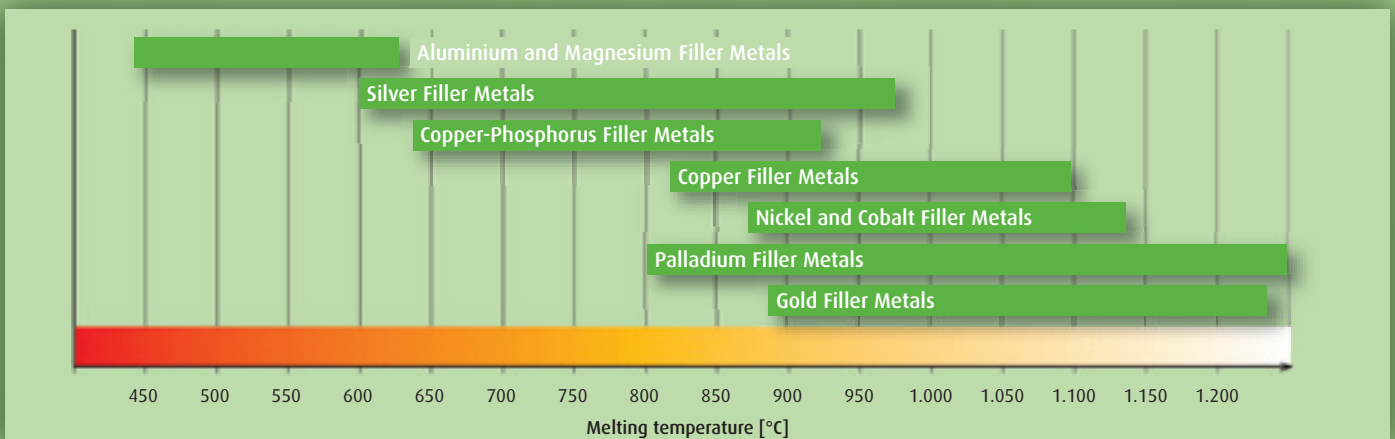

6. Fluxes

According to DIN ISO 857-2, a flux is a non-metal material which is predominantly designated to remove oxides on the surfaces to be brazed and to prevent renewed oxide formation.

Flux wets metal oxides, dissolves these, and eliminates them from the metal surface. It also protects the metal surface against the effects of oxygen, and has to be entirely removable from the metal surface when the melted filler metal has reached its brazing temperature. The flux can do all this only if

- its melting temperature is at least 50 °C lower than of the applied filler metal and is also fully effective at this temperature, and
- it forms a compact uniform layer which remains in effect at the required brazing temperature and throughout the brazing period.

The effective temperature ranges of these fluxes have to be inline with the brazing temperatures of the applied filler metal. There is a rough distinction between fluxes for soft soldering and fluxes for brazing. Within these two categories, there are further temperature ranges which have to be coordinated with the filler metals used [18].

In addition, the fluxes must match the differing chemical conditions of the oxides to be dissolved. As a consequence, there is no universal flux [19].

Table 1 | Brazing fluxes according DIN EN 1045

Type	Based on	Working temperature	Application	Residues
FH10	Boron compounds, fluorides	550 °C – 800 °C	General purpose fluxes	Corrosive
FH11	Boron compounds, fluorides, chlorides	550 °C – 800 °C	Copper-aluminium alloys	Corrosive
FH12	Boron compounds, fluorides, boron	550 °C – 850 °C	Stainless and other alloy steels and hard metals	Corrosive
FH20	Boron compounds	700 °C – 1000 °C	General purpose fluxes	Corrosive
FH21	Boron compounds	750 °C – 1100 °C	General purpose fluxes	Non-corrosive
FH30	Boron & silicon compounds, phosphates	>1000 °C	Copper and nickel brazing filler metals	Non-corrosive
FH40	Chloride, fluorides, boron free	600 – 1000 °C	Boron free applications	Corrosive
FL10	Chlorides, fluorides, lithium compounds	> 550 °C	Light metals	Corrosive
FL20	Fluorides	> 550 °C	Light metals	Non-corrosive

6.1 Soldering Fluxes

Fluxes for soft soldering are listed in the DIN EN 29454-1 standard [20].

To explain how soft soldering fluxes work, here is an example with copper and the hydrous flux type 3.1.2 A (see [table 3](#)) with zinc chloride. Adding thermal energy leads to the following reaction:

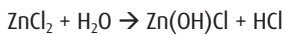

The nascent hydrochloric acid reduces the copper oxide at the component surface to copper chloride. This is soluble in water and can easily be removed from the surface.

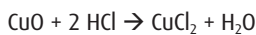

6.2 Brazing Fluxes

Fluxes for brazing are stated in the DIN EN 1045 standard [21]. Excerpts from this standard stating the essential flux types with flux basis materials are listed in the [table 1](#).

The fluxes' soluble capacities are not identical for all metal oxides. For the flux BrazeTec h, the soluble capacities for the most frequent heavy metal oxides were measured at various temperatures. At a temperature range of be-

tween 650 to 750 °C, it can dissolve between approximately 1 (Cr₂O₃) to 5 (ZnO) percent in weight of metal oxide. If the flux is saturated with metal oxide, it loses its effectiveness. As a consequence, the brazing period is limited when brazing with flux in air.

This also means that an appropriately large amount of molten flux must be available to eliminate the oxides, as in the other case the brazing process will be faulty. Extremely narrow gaps, e.g. less than 0.05 mm, might cause difficulties because there may not be an adequate amount of flux in the gap. This of course has a major impact on constructional design as relates to brazing capacities.

A flux may not be expected to have a service life of more than 5 minutes; real-life applications usually have a much shorter service life.

In many instances, the flux will turn black, which clearly indicates that it is saturated – see [figure 17](#). If brazing has not yet been completed to this point of time, the work phase will have to be aborted. Addition of fresh unspent flux is now also no longer possible. To achieve a flawless brazed joint, the following steps must be taken: the component must cool off and be cleaned. New flux must be applied,

and the structure is then heated. A burner with a higher heat capacity must be used or higher inductive output must be applied in order to rapidly heat the component part. However, it is often impossible to heat heavy massive parts to the required brazing temperature with this method. In these cases, the parts must be heated in furnaces in a protective gas atmosphere.

The residues of hygroscopic fluxes must be removed, as these could have corrosive effects. This is done by immersion in hot water or by pickling in pickling baths adapted to the specific parent material. Ultrasonic may also be used to remove these flux residues.

The residues of non-hygroscopic fluxes are not removed for corrosive considerations. If they must be removed for other reasons (e.g. lacquering), this is usually done by mechanical means (e.g. sandblasting).

Figure 17 | Schematic illustration of flux reactions in brazing

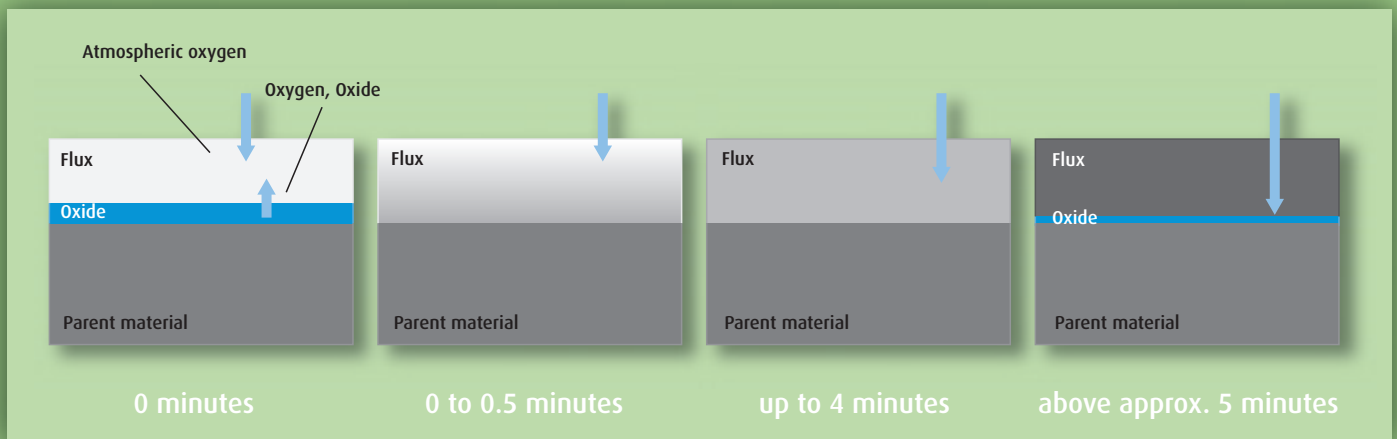

6.3 Gaseous Fluxes

Brazing joints (V-seams and fillet welds) may be brazed with gaseous fluxes. In order to close brazing gaps – in particular if the gaps are narrow and deep - the use of gaseous fluxes alone is not recommendable because the flame will not penetrate into the capillary gap. These fluxes are also not suited for chromium-nickel steels. If applicable, gaseous fluxes may be applied in addition to other fluxes in order to protect the surface against oxidation.

During the flame brazing operation the gaseous fluxes are reacting with the oxygen from the air and forming boric acid, which can be found as a smallest particle in the air, on the brazed part and the machinery. Since December 2010 boric acid has to be classified as toxic substance in the European Union [22] and the brazer has to be protected against the boric acid dust.

The active temperature range of gaseous fluxes extends from approx. 750 °C to 1100 °C.

6.4 Brazing With Flux-Forming Filler Metals

Copper, copper-tin alloys as well as silver may be brazed with phosphoric brazing filler metals without adding fluxes. The self-fluxing effect of these filler metals can be explained as follows:

When the filler metal melts, the phosphorous incorporated in the filler metals reacts with atmospheric oxygen to form phosphorous pentoxide, which reacts with the copper oxide on the copper surface to form copper metaphosphate acting as a flux. Copper metaphosphate forms a dark, non-water-soluble film without any corrosive elements – see **figure 18**. As a consequence, the brazed joints will not require any post-brazing treatment. If so required, copper metaphosphate may be removed by washing with diluted sulphuric acid.

Brazing time with BrazeTec Copper Phosphorous filler metals should also not exceed 3 to 4 minutes.

Figure 18 | Typical copper phosphorous brazed joint



7. Solderability of Components

DIN 8514 defines solderability of a component as the ability of being manufactured by brazing or soldering and thereby being able to meet the specific requirements on that particular component part [23].

A component is brazeable / solderable (see **page 22**) if

- a) the parent material is suited for brazing / soldering,
- b) the application of one or various brazing / soldering techniques is feasible,
- c) the parts can be reliably joined and the new brazed part is able to meet the specified requirements.

Each one of the three characteristics: material solderability, constructional solderability and procedural solderability depends upon the parameters: material, production process,

and design engineering, to an extent depending on the relevant brazing/soldering application.

Table 2 shows the suitability of materials for brazing.

The annexed **Table 6** has a number of recommendations on how to braze the above materials. However, this does not necessarily imply that the joined components will be able to meet all specific operational requirements. In order to warrant for such quality, the operational circumstances must be known before selecting a specific brazing technique. These conditions are specific to

each workpiece and will differ from case to case. In particular high-risk cases we advise you to consult us for definition of the best-suited brazing parameters.

Brazing has the one major advantage that almost all materials suited for brazing may be joined with each other in almost all combinations.

Brazing parameters must always be based on whichever material is the most difficult in terms of brazing.

Table 2 | Suitability of Materials for Brazing

Group 1	Group 2	Group 3
<p>Materials which can be brazed with universal filler metals and fluxes and by all standard techniques.</p> <p>e.g.</p> <ul style="list-style-type: none"> • copper and copper alloys • nickel and nickel alloys • ferrous materials • common steels • cobalt • precious metals 	<p>Materials which require special filler metals and/or special fluxes but not special brazing techniques.</p> <p>e.g.</p> <ul style="list-style-type: none"> • aluminium and aluminium alloys • carbide metals, stellite • chromium, molybdenum, tungsten, tantalum, niobium • materials similar to soft solder 	<p>Materials which can be brazed only with special filler metals and special techniques.</p> <p>e.g.</p> <ul style="list-style-type: none"> • titanium • zirconium • beryllium • ceramics

8. Annex

Table 3 | Fluxes for Soldering Metal Materials according DIN EN 29454-1

Flux categories	Flux base	Flux activator	Consistency
1 Resin	1 With pine resin 2 Without pine resin	1 Without activator 2 Activated with halogens 3 Activated without halogens	A Liquid
2 Organic	1 Water soluble 2 Not water soluble		
3 Inorganic	1 Salts	1 With Ammonia chloride 2 Without Ammonia chloride	B Solid
	2 Acids	1 With phosphoric acid 2 With other acids	C Paste
	3 Alkaline	1 With amines and/or ammonia	

Table 4 | Filler Metal Categories for Brazing and Soldering

Categories	Brazing/ soldering temp. range °C	Typical filler metals in this category Nomen- clature as in DIN EN ISO 9453 or DIN EN 1044	BrazeTec- nomenclature	Solidus temp. °C	Liquidus- temp. °C	Max. admissible continuous oper- ation temp. ¹⁾ °C	Major fields of application
Tin-antimony soft solder EN DIN EN ISO 9453& ISO 3677	250	201 Sn95Sb5	Soldamoll 235	235	240	110	Refrigeration industry
Tin-copper soft solders EN DIN EN ISO 9453& ISO 3677	230 – 320	402 Sn97Cu3	Soldamoll 230 (BrazeTec 3)	227	310	110	Copper plumbing for hot and cold water
Tin-silver soft solders DIN EN ISO 9453& ISO 3677	220 – 260	703 Sn96Ag4	Soldamoll 220	221	–	110	Food-processing industry
		702 Sn96Ag3	BrazeTec 4	221	224	–	
Silver brazing filler metals DIN EN ISO 17672	650 – 1100	Ag 156	BrazeTec 5600	620	655	200	Electrical industry
		Ag 145	BrazeTec 4576	640	680	200	Gas and water plumbing
		Ag 134	BrazeTec 3476	630	730	200	Gas and water plumbing
		Ag 244	BrazeTec 4404	675	735	200	Electrical engineering
		Ag 212	BrazeTec 1204	800	830	300	
Mangnese containing special- grade brazing filler metals DIN EN ISO 17672	690 – 1020	Ag 449	BrazeTec 4900	680	705	400	Carbide tools
			BrazeTec 21/68	980	1030	600	
Copper-phosphorous brazing filler metal for copper materials DIN EN ISO 17672	650 – 800	CuP 284	BrazeTec Silfos 15	645	800	150	Electrical industry
		CuP 279	BrazeTec Silfos 2	645	825	150	Copper-pipe installation
		CuP 179	BrazeTec Silfos 94	710	890	150	for gas utilities
Special-grade brazing filler metals for particular applications DIN EN ISO 17672	730 – 960	Ag 272	BrazeTec 7200	780	780	300	Vacuum engineering
		Ag 160	BrazeTec 6009	600	720	200	High-grade steel
Brass brazing filler metals DIN EN ISO 17672	900 – 910	Cu 680	BrazeTec 60/40	870	900	300	Galvanized steel pipes
		Cu 773	BrazeTec 48/10	890	920	300	Automotive engineering
Nickel-based high-temperature brazing filler metals DIN EN ISO 17672	900 – 1200	Ni 710	BrazeTec 897	890	890	–	Heating elements
		Ni 650	BrazeTec 1135	1080	1135	–	EGR-cooler
		Ni 620	BrazeTec 1002	970	1.000	–	EGR-cooler
Copper-based high-temperature brazing filler metals DIN EN ISO 17672	1040–1120	Cu 110	BrazeTec 801	1085	1085	–	High-grade steel
		Cu 922	BrazeTec 802	910	1040	–	High-grade steel
		Cu 925	BrazeTec 803	825	990	–	Copper or steel
Aluminium-based brazing filler metals DIN EN ISO 17672	560 – 600	Al 112	BrazeTec 88/12	575	590	200	Heat exchangers

¹⁾ not standardized

Table 5 | Fluxes for Soldering Metal Materials according DIN EN 29454-1

Flux categories	Flux type	Flux basis	Major fields of application	Conduct of flux residues
Fluxes for soldering heavy metals	3.2.2.	Zinc chloride and/or ammonium chloride and free acids	Chromium-containing steels; highly oxidized workpieces	Corrosive
	3.1.1.	Zinc chloride and/or ammonium chloride	Chromium-free steels and nonferrous metals, if residues can be washed off	
	3.1.1.	Zinc chloride and ammonium chloride in organic composition	Chromium-free steels and nonferrous metals, if flux residues cannot be washed off	Partially corrosive
	2.1.3.	Organic acids		
	2.1.1.	Amines, diamines, urea		
	2.1.2.	Organic halogen compounds		
	1.1.2.	Resins with halogen bearing activators	Copper	Non-corrosive
	1.1.1.	Resins without additives		
1.1.3.	Resins with halogen-free additives			
Fluxes for soldering light metals	3.1.1.	Solder-forming zinc and/or tin chlorides; also with additives	For workpieces that can be washed	Corrosive
	2.1.3.	Organic compounds		
	2.1.2.	Organic halogen compounds		

Table 6 | Suggestions for Selecting Filler Metals, Fluxes and Techniques

Materials	BrazeTec brazing filler metal	BrazeTec Fluxes	Technique ¹⁾	BrazeTec solder	Fluxes	Technique ¹⁾
Cu	BrazeTec Silfos 2 BrazeTec Silfos 94	-	FL / IN ER / PA / VF	BrazeTec 3 BrazeTec 4	Soldaflux 7000	FL / ER
Cu alloys	BrazeTec Silfos 2 BrazeTec 5600 BrazeTec 4404	BrazeTec h				
Ni + Ni alloys	BrazeTec 5600	BrazeTec h	FL / IN / ER / AF	BrazeTec 3	Soldaflux K	FL / ER / IN
Ferrous materials common steels	BrazeTec 4404		PA / VF	Soldamoll 220	Soldaflux K	
Cobalt	BrazeTec 60/40	BrazeTec s	FL / IN / ER / AF	-	-	-
	BrazeTec 48/10		PA / VF			
	BrazeTec 801	-				
Cr and Cr/Ni steels	BrazeTec 6009	BrazeTec Special h	FL / IN / ER	Soldamoll 220	Soldaflux Z	FL / ER / SI
	BrazeTec 897/1002/1135	-	PA / VF			HB / AF
	BrazeTec 7200					
	BrazeTec 801					
Precious metals	BrazeTec 5600	BrazeTec h	FL / ID	Soldamoll 220	Soldaflux K	-
	BrazeTec 7200		AF			
Al and Al alloys (with Mg and/or Si contents ≤ 2 wt%)	BrazeTec L88/12	BrazeTec F30/70	FL AF	-	-	-
Cemented carbides	BrazeTec 4900	BrazeTec Special h	FL	-	-	-
	BrazeTec 49/Cu					
Stellites	BrazeTec 4900	BrazeTec Special s	IN	-	-	-
	BrazeTec 48/10					
	BrazeTec Cu/NiN	PA / VF				
Chromium, Molybdenum, Tungsten, tantalum, niobium	BrazeTec 4900	BrazeTec Special h	FL / IN	-	-	-
	BrazeTec 21/68	BrazeTec Special s	AF / PA			
Zinc	-	-	-	Soldamoll 220	Soldaflux K	FL / ER
Antimony	-	-	-			SI / HB
Titanium	BrazeTec 7200	-	PA (Argon)	-	-	-
	BrazeTec SCP 2		VF			
Zirconium	BrazeTec SCP 2	-	PA (Argon)	-	-	-
Beryllium			VF			
Graphite			PA (Argon)			
Metal oxide ceramics	BrazeTec CB 4	-	VF	-	-	-

¹⁾ FL=Flame; ER=Electrical resistance; PA=Protective atmosphere furnace; SI=Soldering iron; IN=Inductive; AF=Atmospheric furnace; VF=Vacuum furnace; HB=Hot-air blower

9. Technical glossary

A

Active brazing [24]

Active brazing is the direct brazing of ceramic-ceramic and ceramic-metal joints. The active brazing filler metals used for active brazing contain components like titanium, zirconium or hafnium which promote wetting by a reaction at the brazing filler metal / ceramic interface.

Alloy [24]

Compounds of two or more metals are called alloys.

Annealing [24]

The majority of metals used for industrial purposes, e.g. copper, brass, steel for deep-drawing, are generally strengthened by cold-forming processes (pressing, drawing, rolling, etc.). Annealing allows the soft and less strong starting state to be re-established. Other materials like steel or copper-beryllium can be hardened and strengthened by customised heat treatments. It is recommended to consider these two groups of materials separately for brazing.

Arc Brazing [1]

Metal arc brazing processes can be subdivided into gas-shielded metal arc brazing (known as gas metal arc brazing in the US) and gas-shielded brazing with a non-consumable electrode.

The principle of metal arc brazing is almost identical to that of gas metal arc welding, i.e. (tungsten) plasma arc welding with filler wire. The most commonly used filler wires are copper alloys. The melting ranges of these filler materials are lower than those of the parent material(s). Usually, metal arc brazing processes are used with thin steel sheets, which may be coated or uncoated. Due to the lower melting range of the filler material, there is less risk of damage to any coating as well as less risk of the heat affecting the workpiece. Metal arc brazing does not cause significant melting of the parent material(s). Usually, no flux is necessary.

Assembly Gap [1]

Narrow, mainly parallel gap between the components to be brazed, measured at

room temperature.

Automatic Brazing [1]

Brazing in which all operations, including all auxiliary operations such as changing the workpiece, are carried out automatically.

B

Bonding Process [1]

Process by which a bond is created between the liquid phase of the filler metal and the solid parent metal due to metallurgical reaction.

Boiling Point [25]

The boiling point of an element or a substance is the temperature at which the vapor pressure of the liquid equals the environmental pressure surrounding the liquid.

Braze Welding [24]

If the surfaces on the workpiece to be joined are more than 0.5 mm apart, this is considered to be a (brazing) joint (smaller distance = brazing gap). The work procedures and temperature distribution for braze welding and for fusion welding are identical. In braze welding, relatively large amounts of brazing filler metal are used. That is why silver-free brazing fillers BrazeTec 60/40 and BrazeTec 48/10 are almost always used. If a component with a brazing gap cannot tolerate heating over the whole length of the surface to be brazed, braze welding may also be applied.

Brazeability [23]

A component is considered to be solderable / brazeable if the parent material is suited for soldering/brazing, if one or multiple soldering / brazing techniques may be applied, if the designated parts have been constructed in a manner suited for soldering / brazing and the part thus manufactured is safe and suited for the intended use.

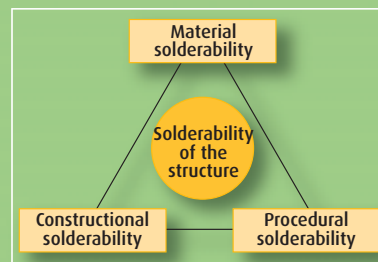

Brazing [1]

Joining process using filler metal with a liquidus temperature above 450 °C.

Brazing Filler Metal [1]

Added metal required for brazed joints, which can be in the form of wire, inserts, powder, pastes, etc.

Brazing Fixtures [26]

Fixtures are used to firmly position brazing parts and to achieve dimensional stability. Brazing fixtures must be particularly adapted to the applied brazing method and its specific requirements.

Brazing Gap [1]

Narrow, mainly parallel gap between the components to be brazed, measured at the brazing temperature.

Braze Metal [1]

Metal formed by the brazing process. NOTE Because the filler metal has melted, its chemical composition may change due to reactions with the parent material(s).

Brazing Stop-Off [1]

Substance used to prevent undesirable spreading of molten filler metal.

Brazing Temperature [1]

Temperature at the joint where the filler metal wets the surface or where a liquid phase is formed by boundary diffusion and there is sufficient material flow.

With some filler metals, this is below the liquidus temperature of the filler metal.

Brazing Time [1]

Time period for the brazing cycle.

Bright, Metallicly Bright [24]

Visible oxide films (rust and scales) as well as grease and grime must be removed prior to brazing. Thin oxide films (e.g. tarnish) need not be removed from the workpiece if flux is used for brazing.

Butt Joints [27]

Joint connections between two parent materials without any overlapping.

C

Capillary Attraction [1]

Force caused by surface tension which draws the molten filler metal into the gap between the components being joined, even against the force of gravity.

Cemented Carbide [24]

Cemented carbides are sintered metals made from powder mixtures of naturally hard materials. They contain a high proportion of metal carbides, most commonly tungsten carbide (WC). Cobalt in concentrations of between 5-13 wt% is

mainly used as the binder metal. In exceptional cases the cobalt content may be higher.

Ceramics

Brazing of ceramics– see Active brazing.

Clearance

Please refer to brazing gap.

Cooling Time [1]

Time during which the joint cools down from the brazing temperature to ambient temperature. It can include the time necessary for the post heat treatment of the brazed parts.

D

De-wetting [1]

Separation of solid filler material which, although it had spread over the surfaces of the components to be joined, had failed to bond to them because of e.g. inadequate cleaning or fluxing.

Dew Point [25]

This is the temperature at which the water vapour in the air becomes saturated and condensation begins.

Diffusion [24]

In general, the term diffusion refers to a macroscopic mass transport caused by movement of individual atoms along paths which are larger than the interatomic distance.

Diffusion Zone [1]

Layers formed during brazing with a chemical composition that is different from that of the parent material(s) and that of the braze metal.

Dip Soldering [1]

The components are soldered by dipping them in a bath of liquid filler metal. They are wetted with flux before dipping. The dipping speed is selected so that it is just high enough to ensure that each component reaches the soldering temperature during dipping. A visible sign of this is the presence of a positive meniscus (concave surface) at the interface between the filler metal surface and the component.

The component to be soldered may be either cold or preheated before dipping.

Dwell Temperature

See equalizing temperature.

Dwell Time

See equalizing time.

E

Effective Time [1]

time during which the flux remains effective during the brazing operation. It is dependent on the procedure used.

Effective Temperature Range [24]

The temperature range in which fluxes or protective gas atmospheres are effective.

Electron-Beam Brazing [1]

Heat is generated in the component, at the joint being brazed, by absorption of a focussed electron beam. The process is usually carried out under a vacuum.

Equalizing Temperature [1]

Temperature at which the components being joined are held so that they are uniformly heated through. It is lower than the solidus temperature of the filler metal.

Equalizing Time[1]

Time during which the components to be brazed are held at the equalizing/pre-heating temperature.

Eutectic Alloys [24]

Just like pure metals, eutectic alloys have a melting point rather than a melting range. The best-known example in brazing technology of a eutectic alloy is BrazeTec 7200, comprising 72 wt% silver and 28 wt% copper and with a melting point of 780 °C.

F

Filler Metal Foil [1]

Brazing filler metal or brazing filler metal powder as foils, with or without binder.

Filling Degree [28]

Percentage of the total brazing gap volume filled up by the brazing alloy.

Flame Brazing [1]

A gas-operated torch is used as the heat source. The torch is adjusted to produce a neutral or slightly reducing flame.

Flammable Gases [24]

Pipes used for transporting gases for public and private gas utility companies in Germany must be brazed. In accordance with the DVGW (German association for gas and water) working sheet GW2, silver brazing filler metals BrazeTec 4576, 3476 and 4404 and also phosphorous-containing brazing filler metals BrazeTec S 94 and S 2 are permitted. If sulphur-containing media (e.g. engine oils, air from stalls, etc.) might possibly

come into contact with the brazed joints, phosphorous-containing brazing filler metals may not be used. In accordance with DIN ENISO 9539 [29] acetylene pipes must be brazed with filler metals which do not contain more than 46 wt% Ag and not more than 36 wt% Cu (BrazeTec 4576 or 4404).

Flow Path [1]

Distance through which the molten filler metal flows in the joint.

Flux [1]

Non-metallic material which, when molten, promotes wetting by removing existing oxide or other detrimental films from the surfaces to be joined and prevents their re-formation during the joining operation.

Flux Vapours [24]

The vapours that are produced when brazing with fluxes are irritating and corrosive. Extraction of the vapours is always recommended. If the relevant applicable WEL-values (Workplace Exposure Limits) are exceeded, brazing work must be carried out with extraction of the vapours.

Furnace Brazing [1]

The components to be brazed are heated by means of radiant heat and/or convection of the hot gas in the furnace. The components are fixed relative to each other. The brazing filler metal is put in place before heating starts. Usually, the process is carried out without flux in a reducing-gas atmosphere or in a vacuum. In some cases, an inert protective gas atmosphere may be used and/or flux, e.g. for aluminium alloys.

G

Galvanising [24]

If the surfaces of the components are to be galvanised after brazing, silver brazing filler metals with low melting points are preferred because flux residues are easy to remove. In general, cadmium-free brazing filler metals form smoother fillets. In particular cases, silicone silver brazing filler metals are recommended. When using higher melting point brazing filler metals such as BrazeTec 60/40 or BrazeTec 48/10, the flux residues must be removed mechanically.

Gap Brazing [24]

Gap brazing is the joining of components, whereby a narrow gap between the components is preferably filled with

filler metal by capillary pressure. Workpieces with gap widths below 0.5 mm are brazed using the gap brazing technique.

Gasous Fluxes [24]

Gaseous fluxes are fluxes that are usually formed from volatile liquid mixtures consisting of boric acid esters and a highly volatile solvent as a transport medium. They are only used for flame brazing. In this technique, the flow of fuel gas is passed through the liquid mixture and is enriched with flux. The flux is then passed on to the component to be brazed by the flame and removes the oxides. A disadvantage of using gaseous flux is that it is only effective above approx. 750 °C and does not penetrate into narrow gaps, thus limiting thorough brazing. During the flame brazing operation the gaseous fluxes are reacting with the oxygen from the air and forming boric acid, which can be found as a smallest particle in the air, on the brazed part and the machinery. Since December 2010 boric acid has to be classified as toxic substance in the European Union [21] and the brazer has to be protected against the boric acid dust.

H

Heating Time [1]

Time during which the brazing temperature is reached. It includes the equalizing (preheating) time and can also include other times, e.g. the degassing time.

High Temperature Brazing [4]

Joining process in inert gas atmosphere or vacuum atmosphere with liquidus temperatures over 900 °C.

Holding Time [1]

Time during which the joint is kept at the brazing temperature.

I

Induction Brazing [1]

Heat is generated by an alternating current induced in the components to be brazed. Normally, this kind of brazing is carried out in air with flux, but protective atmosphere may also be used.

The energy density induced in the components decreases rapidly from the surface towards the interior. The depth of penetration is a function of frequency. Medium frequencies (1 000 Hz to 10 000

Hz) give a greater depth of penetration than high frequencies (100 kHz to several MHz).

Inert Gas Atmosphere [1]

Gas which prevents the formation of oxides during the brazing process.

Intercrystalline Diffusion [25]

Filler metal diffusion along the grain boundary of the parent material.

Interfacial Corrosion [24]

Crevice corrosion and knife-edge corrosion are popular names for a form of interfacial corrosion. This occurs for example on stainless steel components which have been brazed with zinc-containing filler metals and which come into contact with aqueous media. The steel surface is usually visibly corroded at the edge and under the brazed joint. The danger of corrosion is reduced by brazing with Zn-free filler metals such as BrazeTec 6009 (Ag 60 wt%, Cu 30 wt%, Sn 10 wt%) and flux. When furnace brazing (without flux), e.g. using copper or nickel based alloys as the filler metals, there have not yet been any incidents of knife-edge corrosion.

L

Lap Joints [27]

Joints of two overlapping parent materials.

Laser beam Brazing [1]

Laser beam brazing can be carried out with CO₂ or Nd:YAG lasers operating in a continuous or pulsed mode. The filler metal is usually applied as filler wire or as brazing paste. A relatively new application for laser beam brazing is the joining of steel sheets, e.g. in the automobile industry. Laser beam brazing processes may also be carried out under a shielding gas or in vacuum.

Liquidus Temperature [24]

The liquidus temperature is the upper temperature limit of the melting range or the melting interval. The filler metal is completely liquid above this temperature.

M

Manual Brazing [1]

Brazing in which all operations are carried out manually.

Maximum Brazing Temperature [24]

The maximum brazing temperature is the temperature up to which the parent material and the filler metal are not

damaged, i.e. heat sources must be chosen to generate adequate temperature-time profiles for the workpiece.

Mechanized Brazing [1]

Brazing in which all the main operations, except the handling of the workpiece, are carried out mechanically.

Melting Point [25]

The melting point of a solid is the temperature at which it changes state from solid to liquid. At the melting point the solid and liquid phase exist in equilibrium.

Melting Temperature Range of the Filler Metal [1]

Temperature range extending from the commencement of melting (solidus temperature) to complete liquefaction (liquidus temperature). Some filler metals have a melting point rather than a melting range.

O

Operating Temperature [24]

Increased operating temperatures almost always lead to considerable loss of strength in brazed joints. The maximum operating temperatures stated in technical data sheets or product information should not be exceeded over long periods. Higher temperatures are generally permitted for short periods if the brazed joints are not subject to significant loads.

Oxygen Content

The oxygen content of supplied inert or protective gases or of the furnace atmospheres are stated in vpm or ppm (1 volume part per million).

P

Partial Alloying [24]

Partial alloying is the strong diffusion of the components of the brazing filler metal into the parent material. As the diffusion is dependent on both time and temperature, the holding time at the brazing temperature should be kept as short as possible, especially for high temperature brazing filler metals, in order to avoid partial alloying of the base material (erosion) and possible formation of brittle phases in the transition zones.

Parent material [1]

Material being brazed.

Partial Pressure [24]

Partial pressure is the pressure that may be attributed to a particular component

in gas compounds, e.g. air. The partial pressure corresponds to the total pressure that the particular components would exert if they were the only single element filling the entire volume. In vacuum brazing, a gas is added to the vacuum atmosphere to prevent vaporisation of the alloy components of the filler metals or the parent materials.

Preformed Filler Metals [24]

Filler metals come in the following forms: wire sections, wire rings, bent pieces of wire, discs, washers, square or rectangular sheet sections and stamped sheets. In particular cases, e.g. for surface brazing, shaped pieces of filler metal must be used for brazing as the rate of flow into narrow surface gaps is considerably smaller than into the free fillet.

Preheating Temperature

See equalizing temperature.

Preheating Time

See equalizing time.

Protective Atmosphere for Brazing [1]

Gas atmosphere or vacuum round a component, either to remove oxide or other detrimental films on the surfaces to be joined or to prevent the re-formation of such films on surfaces which have previously been cleaned.

R

Reconditioning [26]

Reconditioning may be required depending upon brazing process and the materials used. Residues of fluxes, brazing filler metal resists and binders should be removed by rinsing, pickling or mechanical means. The brazing connection must be designed to allow any required reconditioning work and easy removal of any residues.

Reducing Gas Atmosphere [1]

Gas which reduces oxides owing to its high affinity for oxygen. Materials sensitive to oxidation, such as alloys with more than 0.5 % aluminium, titanium or zircon cannot be brazed without flux in reducing protective gas atmospheres [30]. Parts brazed in protective gas atmospheres are metallicly bright and do not require any subsequent treatment.

Resistance Brazing [1]

Heat is generated in the components at the joint by the resistance to the passage of an electric current. This electrical heating enables the components to be brazed either indirectly or directly.

S

Sandwich Brazing Alloys [24]

Layered filler metals consist of a copper layer or a nickel mesh coated with filler metals on both sides. They are used for brazing cemented carbides and are applied to compensate internal tension caused by different thermal coefficients of expansion or contraction.



Salt Bath Brazing [1]

The components are heated by dipping them in a bath containing a mixture of molten salts. The bath is made of a suitable material. Many salt mixtures have also a flux action. The composition of the salt mixture depends on the nature of the parent metal and of the filler metal. Filler metal preforms are placed in the immediate proximity of the joint area prior to immersion.

Solderability

See Brazeability.

Soldering [1]

Joining process using filler metal with a liquidus temperature of 450 °C or less.

Soldering Irons [1]

Soldering irons are used exclusively for soldering. They consist of a metal bit (copper) that is heated, for example electrically or by using a burner. The heat and also the molten solder are transferred to the component by contact of the metal bit with the component, and a soldered joint is thus created.

Soldering with Soldering Iron [1]

Heating the soldering point and melting the filler metal are carried out using a soldering iron operated manually or mechanically. A soldering iron with a heat capacity, shape and tip suitable for the soldering point is used. Both of the components to be joined and the filler metal are brought to the brazing/soldering temperature using a flux, either separately or in the form of a flux-cored filler metal.

Solidus Temperature [24]

The solidus temperature is the lower temperature of the melting range or melting interval. The filler metal is completely solid below this temperature.

Step Brazing [28]

The brazing of secondary joints on component parts with a filler metal with a lower brazing temperature without interfering with the primary brazed joints.

Strength of Brazed Parts [26]

The strength of brazed joints depends upon the type of brazing alloy, engineering design, capillary joint, overlap, the parent material and its preparatory treatment as well as overall preprocessing. The quality and thus also stability of brazed joints depends upon the chosen processes. It is advisable to achieve a specified shearing load. Strength values shall be determined per component part. Please refer to manufacturer information for reference values.

Surface Brazing [24]

Surface brazing is coating using brazing techniques. The coatings can be used for protection against wear and corrosion.

T

T-Butt [27]

The parts butt square (T-shaped) on each other.

Temperature-Time Scheme [31]

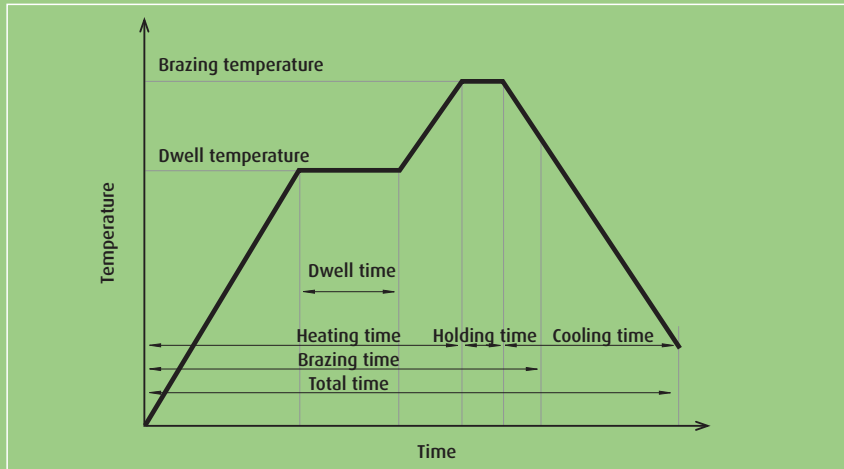

Thermal Influence Zone [1]

That area of the base materials affected by the brazing process.

Thermocouple [25]

A thermocouple (thermal converter) consists of two different metals connected to each other at one end. Thermocouples are used for measuring temperatures at component parts and/or the atmosphere.

Torches [24]

Torches are instruments for heating components in regular atmosphere. There are torches for different gaseous combinations: acetylene/oxygen; acetylene/intake air; propane/oxygen; propane/intake air; natural gas/oxygen, natural gas/compressed air or hydrogen torches. The selected gas combination and size of the burner head determine the time required for brazing.

Total Time [1]

Period which includes the heating time, the holding time and the cooling time

Transition Zone

See diffusion zone.

V

Vacuum, Vacuum Brazing [1]

pressure sufficiently below atmospheric so that the formation of oxides will be prevented to a degree sufficient for satisfactory brazing, because of the low partial pressure of the residual gas. As a vacuum can only eliminate oxides to a very limited extent, preparatory cleaning of the surfaces to be wetted is of the greatest importance.

Vacuum Brazing Alloys [24]

All those brazing filler metals with alloy components developing high vapour pressures at brazing temperature are not suited for a vacuum brazing filler metal, for example all filler metals containing volatile elements such as cadmium or zinc. Brazing in a vacuum is usually done in furnaces, with resistance-heated or induction-heated vacuum furnaces being predominantly used.

While flux and gases may become trapped in brazing gaps when brazing in atmosphere, this is virtually never the case when brazing in a vacuum, thus resulting in brazed joints with a good degree of filling and high strength.

Vapour Pressure [25]

Vapour pressure is a gas pressure dependent upon substance and temperature. In clear terms, vapour pressure is the ambient pressure below which liquids - held at constant temperature - begin to dissolve into a gaseous state of aggregation. If there are various substances in the examined system, the measured pressure of the gaseous phase is composed of the partial pressures of these various substances.

W

Wetting

In brazing technology, wetting is the spreading of the filler metal over the surface of the workpiece to be joined [1]. Filler metals only wet the base material if the surfaces to be brazed and the filler metal are metallically bright. Furthermore, the surfaces to be brazed and the filler metal must at least have reached the working temperature of the used

filler metal and at least one part of the filler metal must readily form an alloy with the base material to be brazed [24].

Wetting Angle

See 3.1, page 8

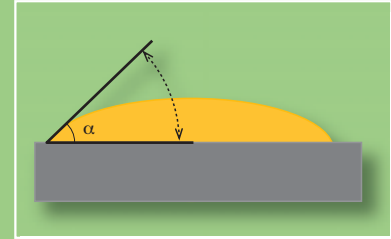

Working Temperature [32]

The working temperature is the lowest surface temperature at the point to be brazed at which the brazing alloy wets the materials to be joined or at which a liquid phase forms via interfacial diffusion. The working temperature is not defined in any standard since publication of ISO 857-2.

Literature

- [1] DIN ISO 857-2:2007-05: Welding and allied processes Vocabulary Part 2: Soldering and brazing processes and related terms-First Edition
- [2] Massalski, T.B.: Binary Alloy Phase Diagrams, ASM International (1996)
- [3] Zaremba, P.: Hart- und Temperaturlöten, S. 10, DVS Verlag (1988)
- [4] N.N.: Technik, die verbindet, Band 1, S. 3-4, Degussa AG (1987)
- [5] Dorn, L.: Hartlöten und Hochtemperaturlöten, S. 11, expert Verlag (2007)
- [6] Zaremba, P.: Hart- und Temperaturlöten, S. 8, DVS Verlag (1988)
- [7] Dorn, L.: Hartlöten und Hochtemperaturlöten, S. 21, expert Verlag (2007)
- [8] Wuich, W.: Löten, S. 55, Vogel-Verlag (1972)
- [9] Zimmermann, K.: Technik, die verbindet, Band 4, S. 28, Degussa AG (1990)
- [10] Beckert, M.: Grundlagen der Schweißtechnik – Löten, S. 32, VEB Verlag Technik Berlin (1973)
- [11] N.N.: Grundlagen des Lötens (L), Degussa AG (1996)
- [12] www.innobraze.com/
- [13] DIN EN ISO 9453:2006-12: Soft Solder Alloys - Chemical Compositions and Forms-Second Edition
- [14] DIN EN DIN EN ISO 17672:2010-11: Brazing Filler metals-First Edition
- [15] <http://www.cuprobraz.com>
- [16] Weise, W., Malikowski W., Krappitz, H.: Verbinden von Keramik mit Keramik oder Metal durch Aktivlöten unter Argon oder Vakuum, Dagussa-Hüls AG (1999)
- [17] COMMISSION REGULATION (EC) No 494/2011 amending Regulation (EC) No 1907/2006 of the European Parliament and of the Council on the Registration, Evaluation, Authorisation and Restriction of Chemicals (REACH) as regards Annex XVII (Cadmium)
- [18] Wuich, W.: Löten, S. 97, Vogel-Verlag (1972)
- [19] Müller, W.: Löttechnik, S. 60, DVS Verlag (1995)
- [20] DIN EN 29454-1:1994-02: Soft soldering fluxes - Classification and requirements - Part 1: Classification, labelling and packaging
- [21] DIN EN 1045:1997-08: Brazing - Fluxes for Brazing - Classification and Technical Delivery Conditions
- [22] COMMISSION REGULATION (EC) No 790/2009 of 10 August 2009 amending, for the purposes of its adaptation to technical and scientific progress, Regulation (EC) No 1272/2008 of the European Parliament and of the Council on classification, labelling and packaging of substances and mixtures
- [23] DIN 8514:2006-05: Brazeability, Solderability
- [24] <http://www.saxonia-tm.de>
- [25] Wikipedia.org/wik (19.07.2013)
- [26] DIN 65169:1986-10; Aerospace; brazed and high-temperature braed components, directions for design
- [27] DIN 1912-4:1981-05; Zeichnerische Dartstellung Schweißen, Löten
- [28] Müller, W.: Löttechnik, S. 2f, DVS Verlag (1995)
- [29] DIN EN ISO 9539:2010-05; Gas welding equipment - Materials for equipment used in gas welding, cutting and allied processes
- [30] Wuich, W.: Löten, S. 52, Vogel-Verlag (1972)
- [31] Prozesskontrolle beim Hochtemperaturlöten, DVS Merkblatt 2607 (2008)
- [32] DIN 8505-1:1979-05: Löten; Allgemeines, Begriffe

Our particulars and statements on our products and equipment as well as installations and processes are based upon extensive research and experience in applications engineering. We impart these findings in speech and writing to the best of our knowledge, and in doing so do not accept any liability extending beyond that stipulated in individual agreements. We reserve the right to technical alterations in the course of technical progress. Our technical services are available if so required for further consultation and to assist with finding solutions for any problems arising in production and application.

However, this shall not release users from their obligation to verify our data and recommendations prior to using these. This applies also to observance of third-party industrial property rights and to applications and procedures we did not specify in writing, in particular for export deliveries. In the event of damages, our liability obligations are restricted to compensation in identical scope and quality as is provided for quality defects in our General Terms and Conditions.